

# MID:COM

## LT SERIAL CABLES & HEADERS HOST, PRINTER, & PROGRAMMING CABLES

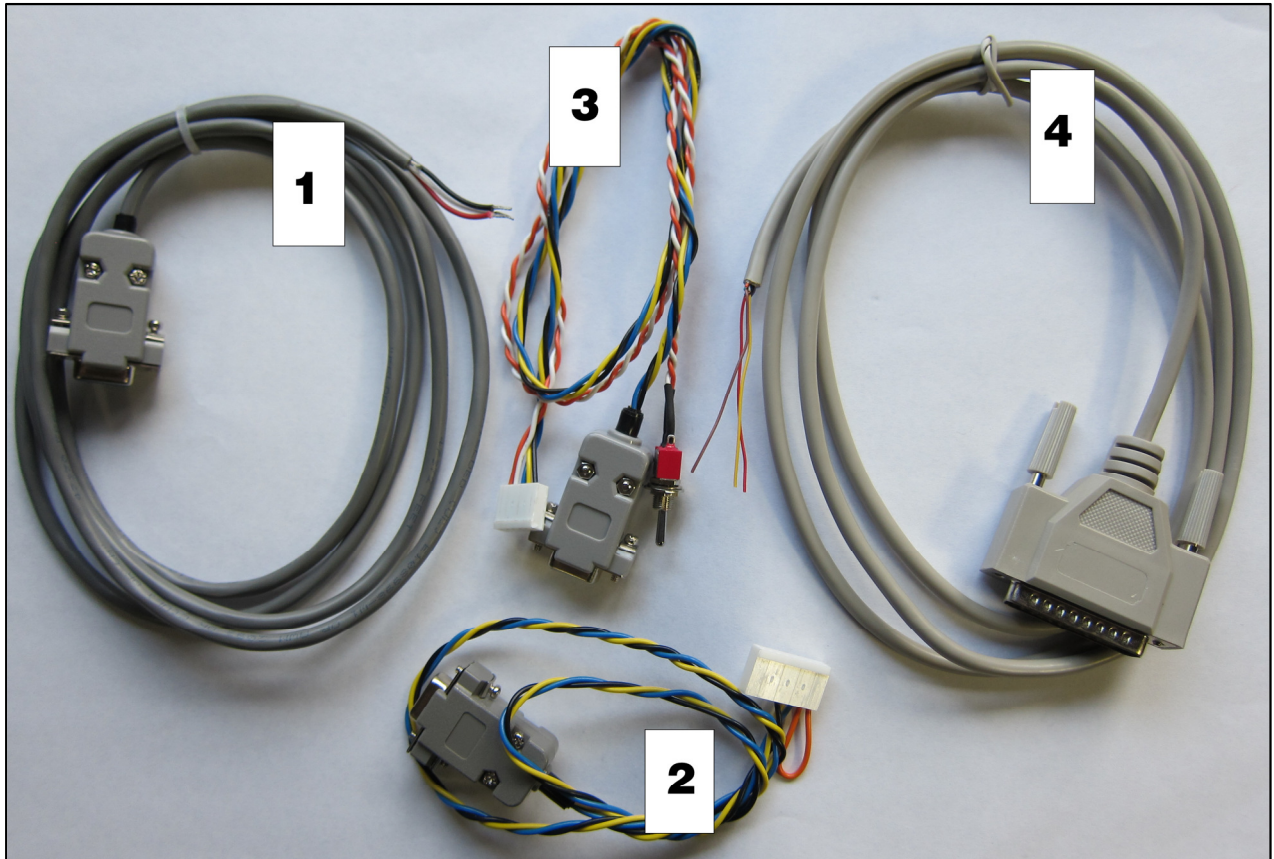

- 1) **ECount LT Host Straight Serial Cable**  
Part# 702-0129 (modified from 114-0100)  
Not required if using a programming harness
- 2) **ECount LT Standard Programming Harness**  
Part# 702-0113
- 3) **ECount LT Developer Programming Harness**  
Part# {pending} (702-0113 modified for developers)
- 4) **ECount LT DB25M Straight Serial Cable for Printers**  
Part# 114-0387

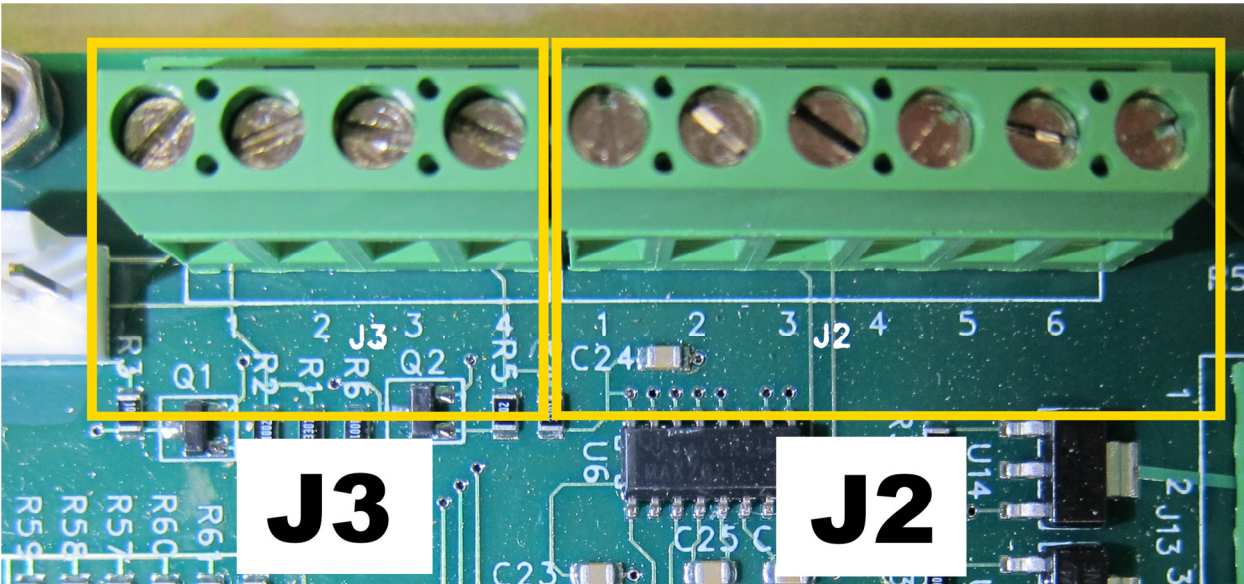

**J3**

**J2**

J3 External Encoder (Pulser)

J2 RS-232 Communication

**J2 RS-232 Communication**

- J2-1 TX PRINTER
- J2-2 RX PRINTER
- J2-3 GROUND
- J2-4 TX HOST SAME AS J5-3
- J2-5 RX HOST SAME AS J5-4
- J2-6 GROUND SAME AS J2-5

**J5 Programming**

- J5-1 SHORTED TO J5-2 ENABLES PROGRAMMING
- J5-3 TX HOST SAME AS J2-4
- J5-4 RX HOST SAME AS J2-5
- J5-5 GROUND SAME AS J2-6

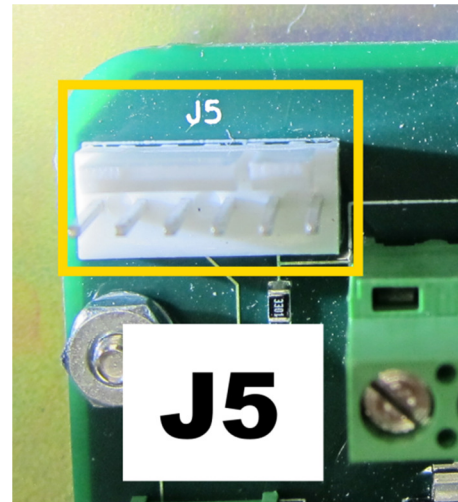

**J5**

J5 Programming (L->R, 6 5 4 3 2 1)

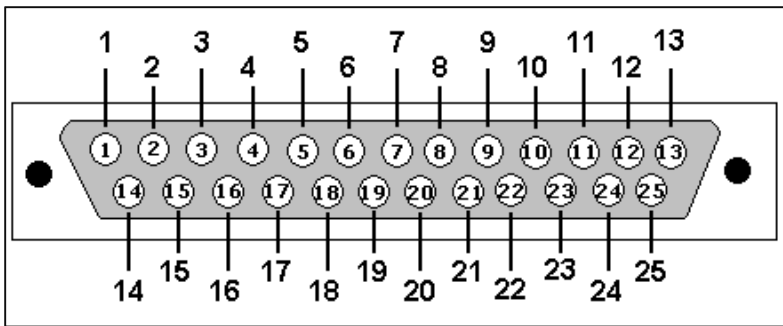

Male Connector Front View



**ECount LT DB25M Straight Serial Cable for Printers Part# 114-0387  
(Modified from Part # 114-0089)**

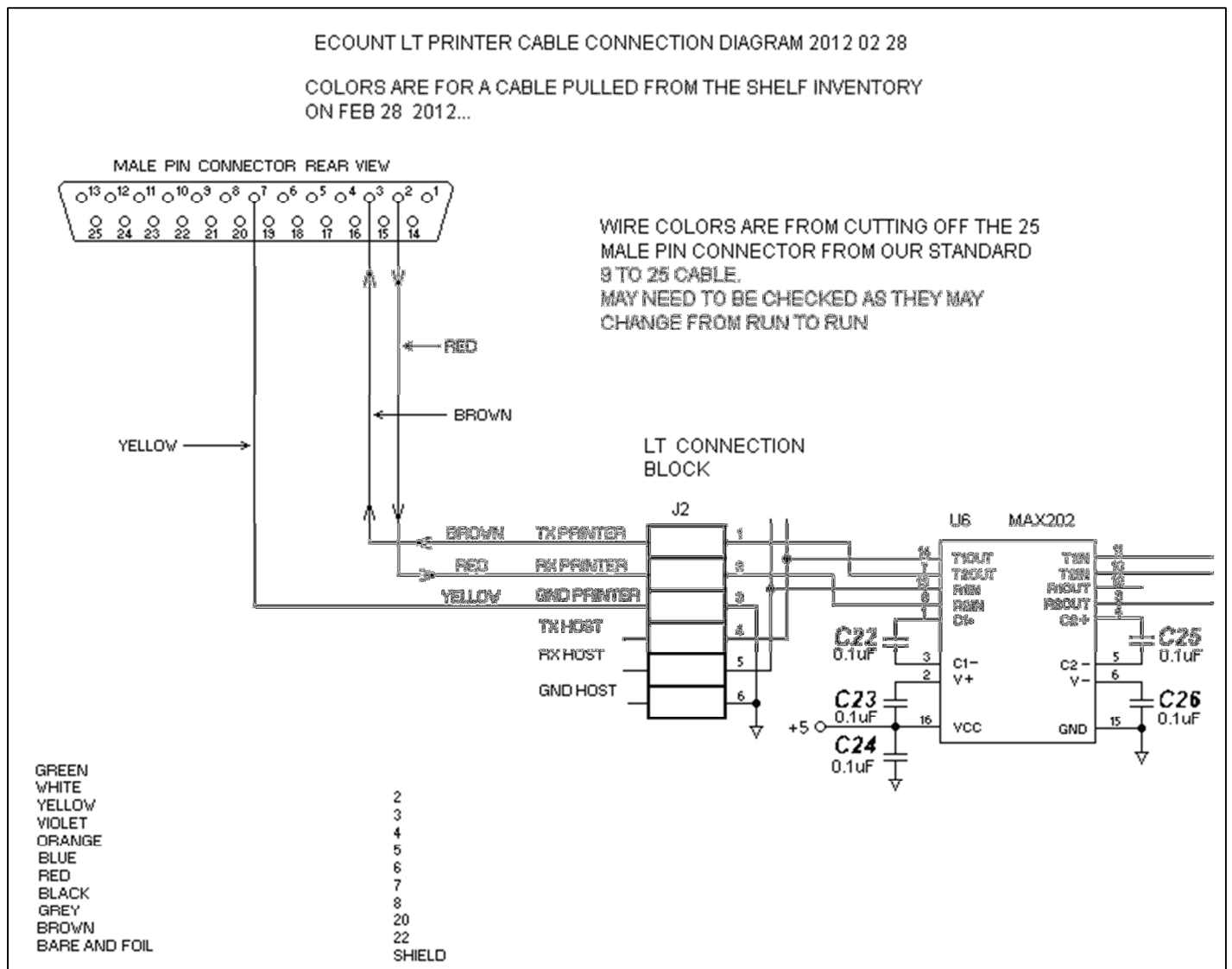



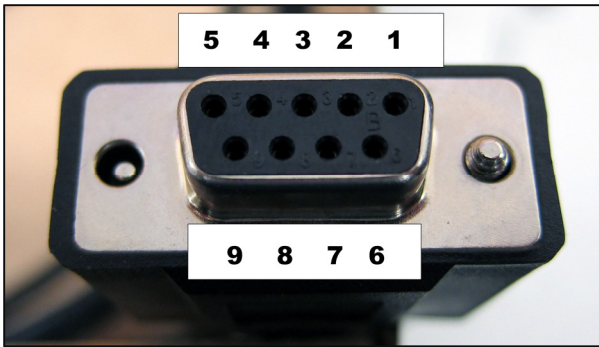

Female Connector Front View, Pre-molded Cable

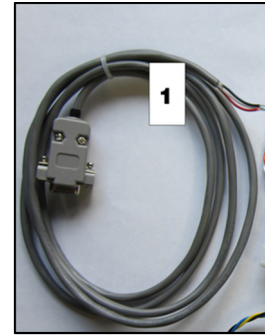

MIDCOM Cable

Pin 2 = TX = Brown  
 Pin 3 = RX = Red  
 Pin 5 = TX = Ground = Yellow + Shield

Pin 2 = TX = Red  
 Pin 3 = RX = Clear  
 Pin 5 = Ground = Black + Bare

**ECount LT Host Communications Straight Serial Cable Part# 702-0129**

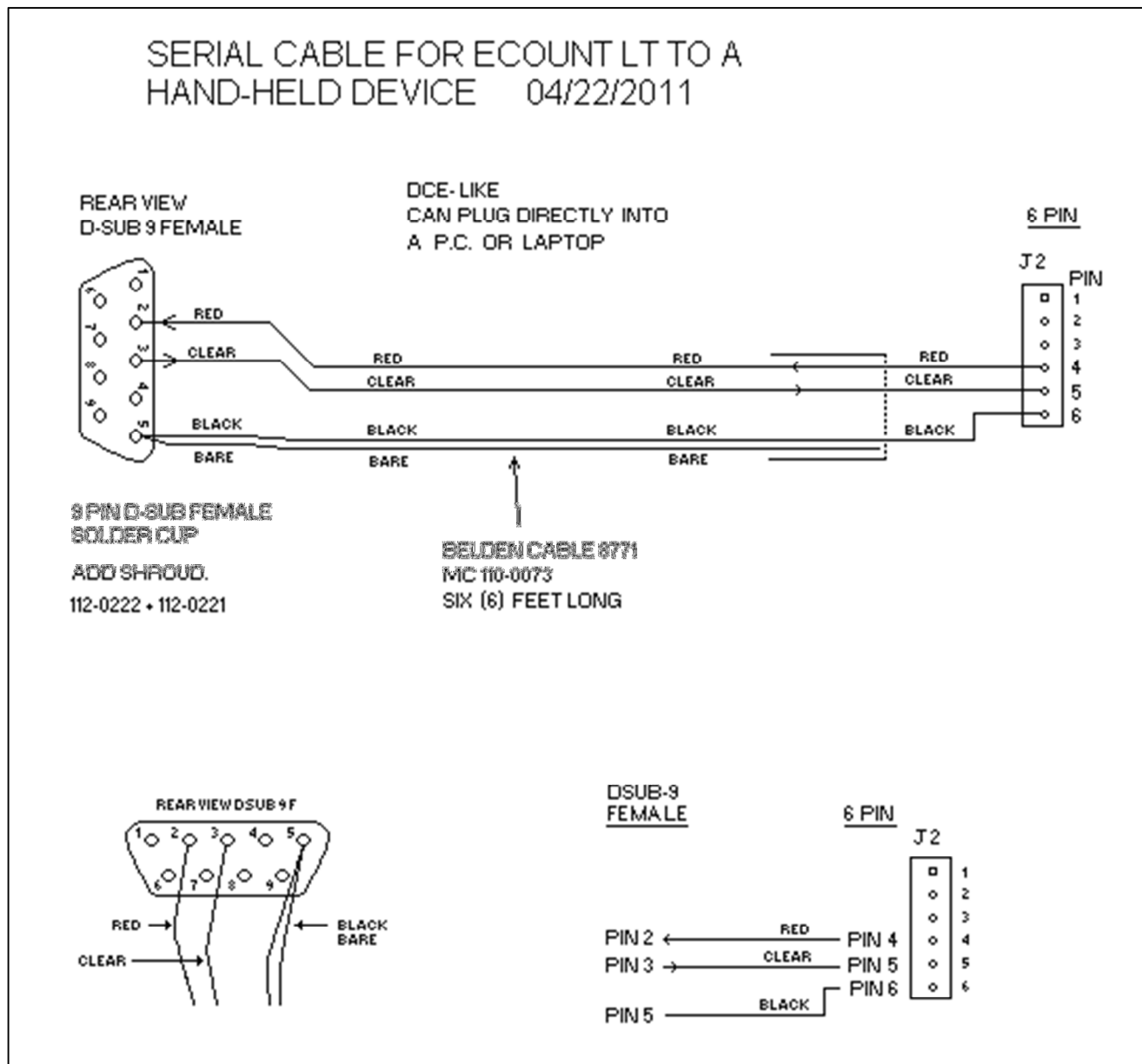

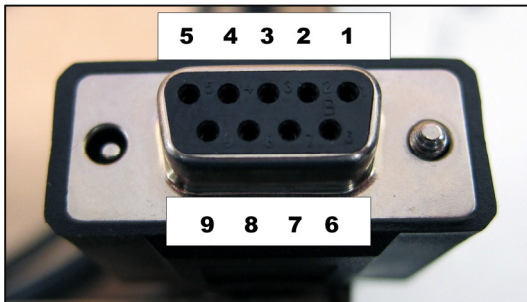
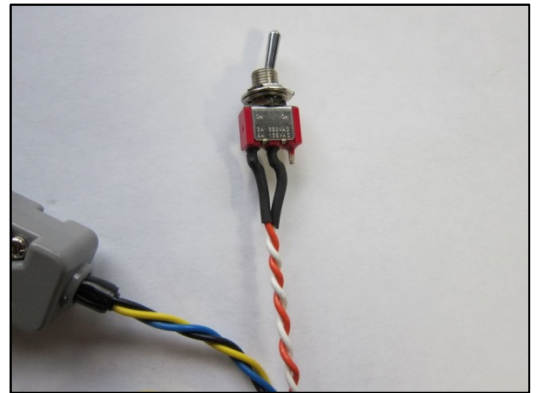
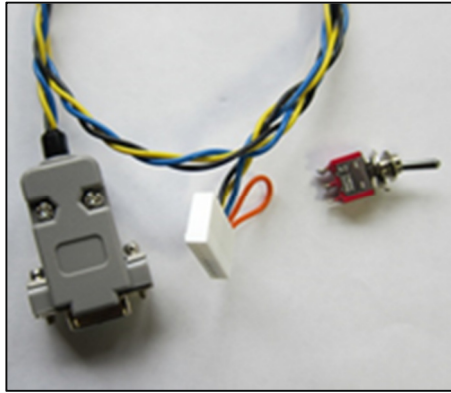

Female Connector Front View

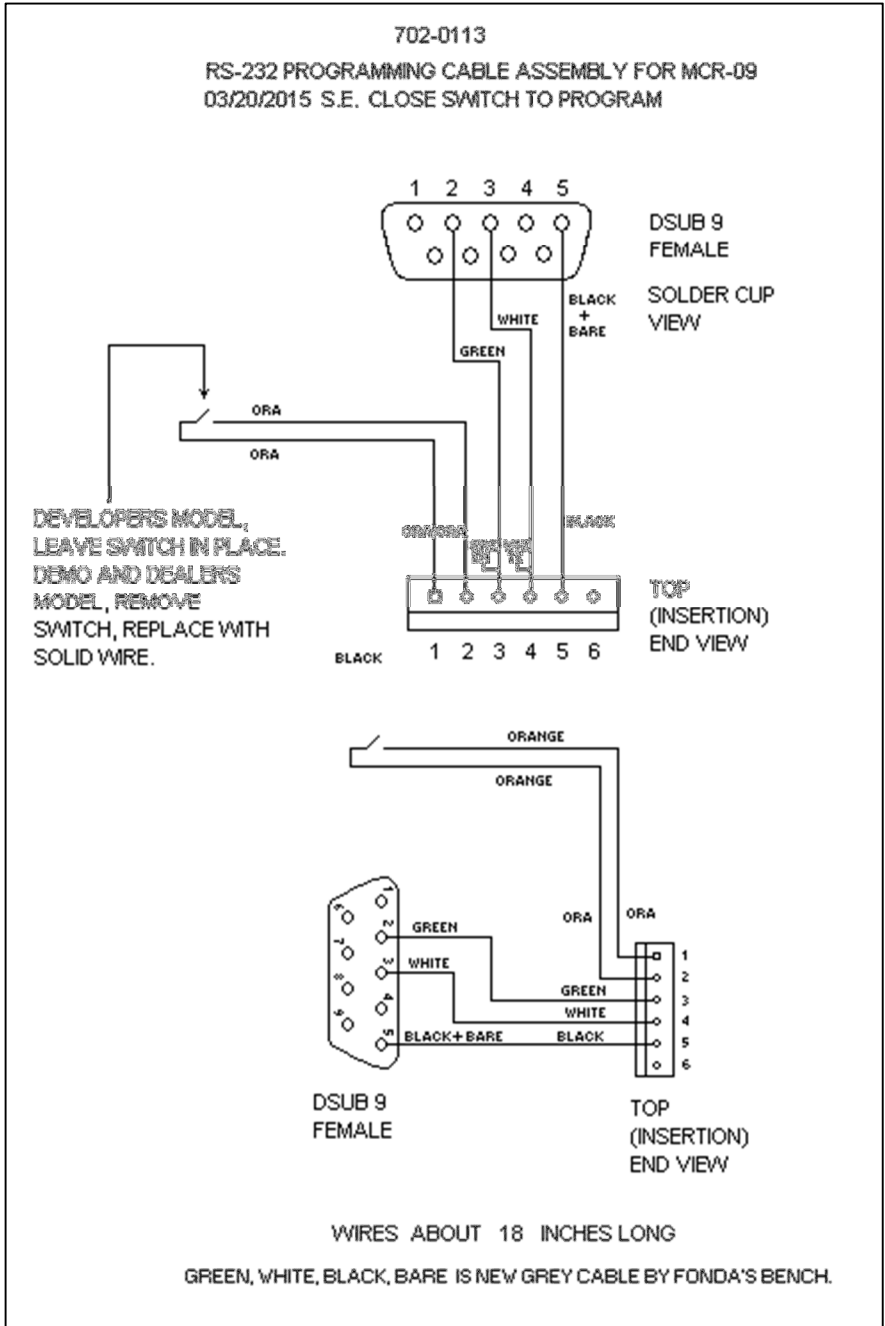

MID:COM  
Midwest Computer Register, Corp.  
1605 170th Street  
PO Box 376  
Hampton, IA 50441  
Telephone 641-456-4848  
Fax 641-456-4600  
sales@MidComCorp.com  
www.MidComCorp.com

November 2015